

Gi 3~17kW

Three-phase String Inverter

User Manual

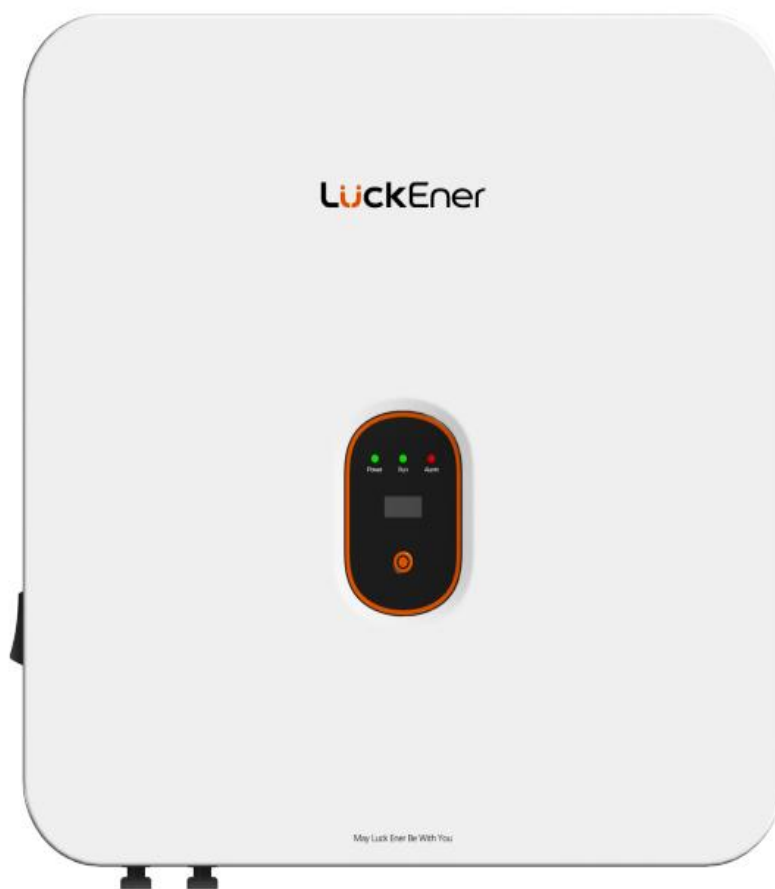

Catalogue

1. Information on this Manual	1
1.1 Scope of Validity	1
1.2 Statement	1
1.3 Safety instruction	1
2. Product Introduction	3
2.1 Product Appearance	3
2.2 Product Features	3
3. Installation Guide	4
3.1 Packaging	4
3.2 Tool Preparation	5
3.3 Installation Environment Requirements	5
3.4 Mounting Procedure	7
3.5 Electrical Connections	8
3.5.1 PV Connection	9
3.5.2 AC Connection	11
3.5.3 Grounding	12
3.5.4 Communication Connection	14
4. Operation	15
4.1 Power ON/OFF	15
4.2 Display Panel	16
4.3 LED Indicator	16
4.4 Button	16
4.5 LCD Interface	17
4.5.1 Display Information	17
4.5.2 History Fault Settings	18
4.5.3 Language Settings	18
4.5.4 Safety Settings	19
4.5.5 Modbus Address Settings	20
5. Maintenance	20
5.1 Routine Care	21
5.2 Safety Notes for Maintenance	22
6. Troubleshooting	23
7. Specification	25

1. Information on this Manual

1.1 Scope of Validity

This manual is an integral part of the string inverter (Hereinafter in this manual referred to as “inverter” or “product” or “device”), which describes the assembly, installation, commissioning, maintenance and troubleshooting of the following models of products:

Gi003K-A1.11-P3NV-L; Gi004K-A1.11-P3NV-L; Gi005K-A1.11-P3NV-L;
Gi006K-A1.11-P3NV-L; Gi007K-A1.11-P3NV-L; Gi007K-A1.22-P3NV-L;
Gi008K-A1.22-P3NV-L; Gi009K-A1.22-P3NV-L; Gi010K-A1.22-P3NV-L;
Gi012K-A1.22-P3NV-L; Gi015K-A1.22-P3NV-L; Gi017K-A1.22-P3NV-L.



Note: Please keep this manual where it will be accessible at all times.

1.2 Statement

Due to ongoing product improvements, Jiangsu LT Technology Co., Ltd.(Hereinafter in this manual referred to as LT) reserves the right to modify product features and specifications at any time without prior notice. The latest version of this manual is available on the official website (www.lt-ess.com). Although great care has been taken to ensure accuracy, LT assumes no responsibility for any errors, omissions, or damages—whether direct, indirect, or consequential—arising from the use of this document or from outdated information it may contain.

LT shall not be held liable for any losses resulting from improper installation, incorrect operation, or compatibility issues involving third-party systems. The responsibility for correct installation and compliance with local regulations rests solely with the customer.

Any unauthorized hardware or software alterations, repairs, or modifications will immediately void the product warranty.

LT accepts no responsibility for damage or malfunction caused by misuse, mishandling, or failure to follow the safety instruction. This device operates at potentially lethal voltages and must only be installed by professionals who are qualified in operating high-voltage equipment.







1.3 Safety instruction

This section contains important information of safety and operating precautions. Read and save this manual for future reference. Before installing and operating this device, please thoroughly read all instructions in this manual and check warning signs on the device. Make sure you understand the working mechanism of inverter and all relevant sections in this manual.

Before installation, users must ensure that:

- Adequate space and ventilation are available for safe equipment operation.
- Environmental noise and potential fire risks have been properly considered and evaluated.
- The device is operated only under permissible environmental and transportation conditions.
- Maintenance could be performed correctly and regularly only by qualified personnel.
- The device is not tampered with, improperly repaired by, or installed by unqualified individuals.

The following label instructions appear in this document and inverter as described below:

	<p>The inverter can not be disposed together with the household waste. Disposal information can be found in the enclosed documentation.</p>
	<p>Warning! Attention and cautions are called! Operations might cause equipment damage or human injuries!</p>
	<p>Beware of hot surface. The energy station can become hot during operation. Avoid contact during operation.</p>
	<p>Danger to life due to high voltage. There is residual voltage existing in the inverter after powering off, which needs 5 min to discharge. Wait 5 minutes before you open the upper lid or the DC lid.</p>
	<p>Danger of high voltages and electric shock! Danger to life due to high voltages in the inverter!</p>
	<p>Please refer to the instructions carefully before use.</p>
	<p>Symbol Explanation CE mark. The energy station complies with the requirements of the applicable CE guidelines.</p>

2. Product Introduction

2.1 Product Appearance

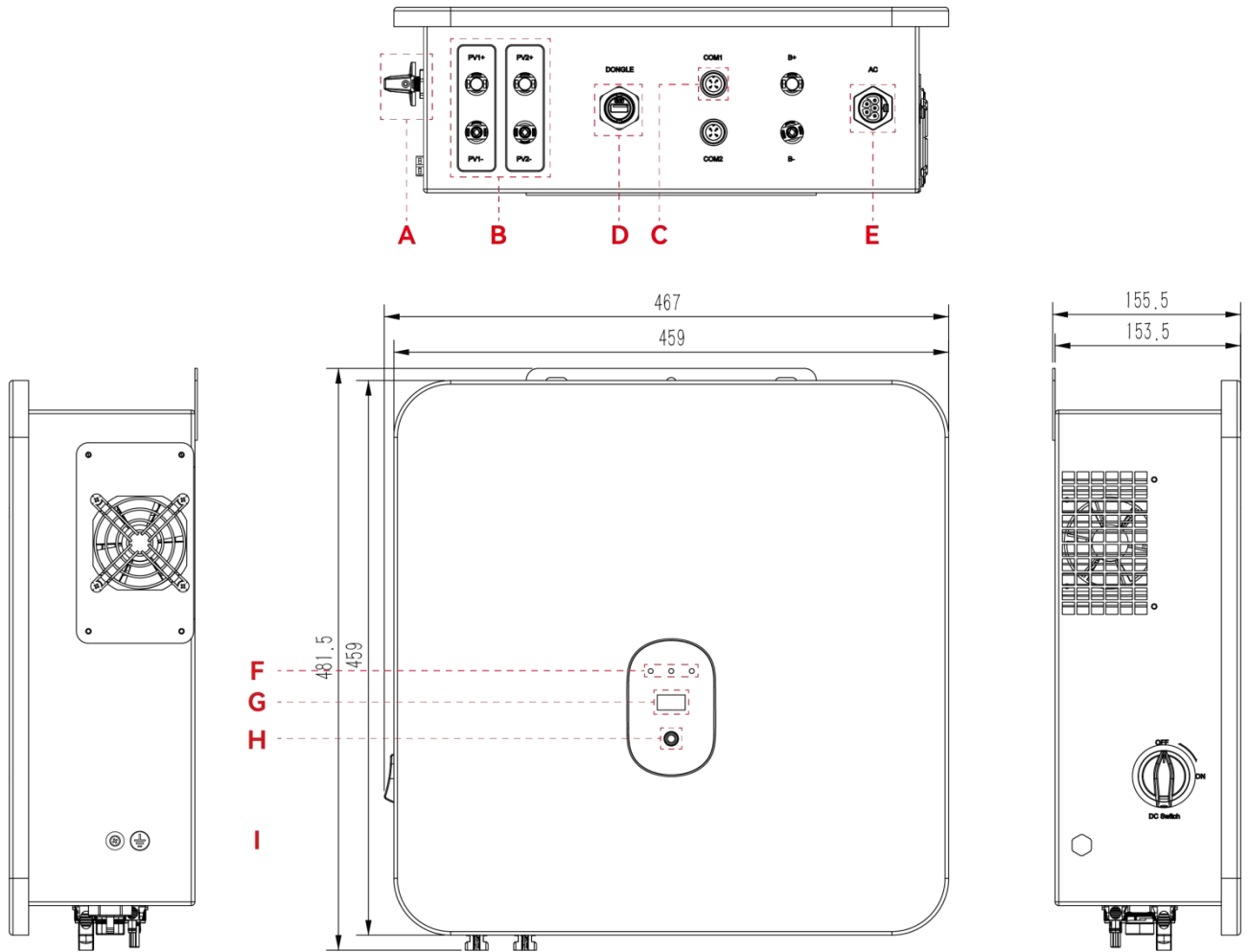

A: DC switch	B: PV input	C: COM port (For CT / Smart meter)
D: WiFi interface	E: AC output	F: Inverter indicators
G: LCD display	H: Operation button	I: Earth connection

2.2 Product Features

The LT string inverter incorporates advanced technology to manage power resources efficiently and safely:

- **150%** DC/AC ratio for maximum solar power utilization

- Up to 2 MPPTs design with **98.5%** efficiency, ensuring maximum energy utilization
- 160V** startup voltage and **120-1000V MPPT range**, enabling longer daily power generation time
- 110% continuous overload output to achieve higher power generation capability.
- Advanced grid adaptability ensures reliable operation under weak-grid conditions.
- Export power control** for precise grid-feed to meet local regulations
- Optional **AFCI** function, reducing fire risks and improving long-term system reliability.
- Integrated **Type II SPD** on both DC and AC sides for comprehensive surge protection
- IP66** protection rating, ensuring dependable operation in harsh environmental conditions

3. Installation Guide

3.1 Packaging

Before starting installation, check that all accessories are included and in good condition.

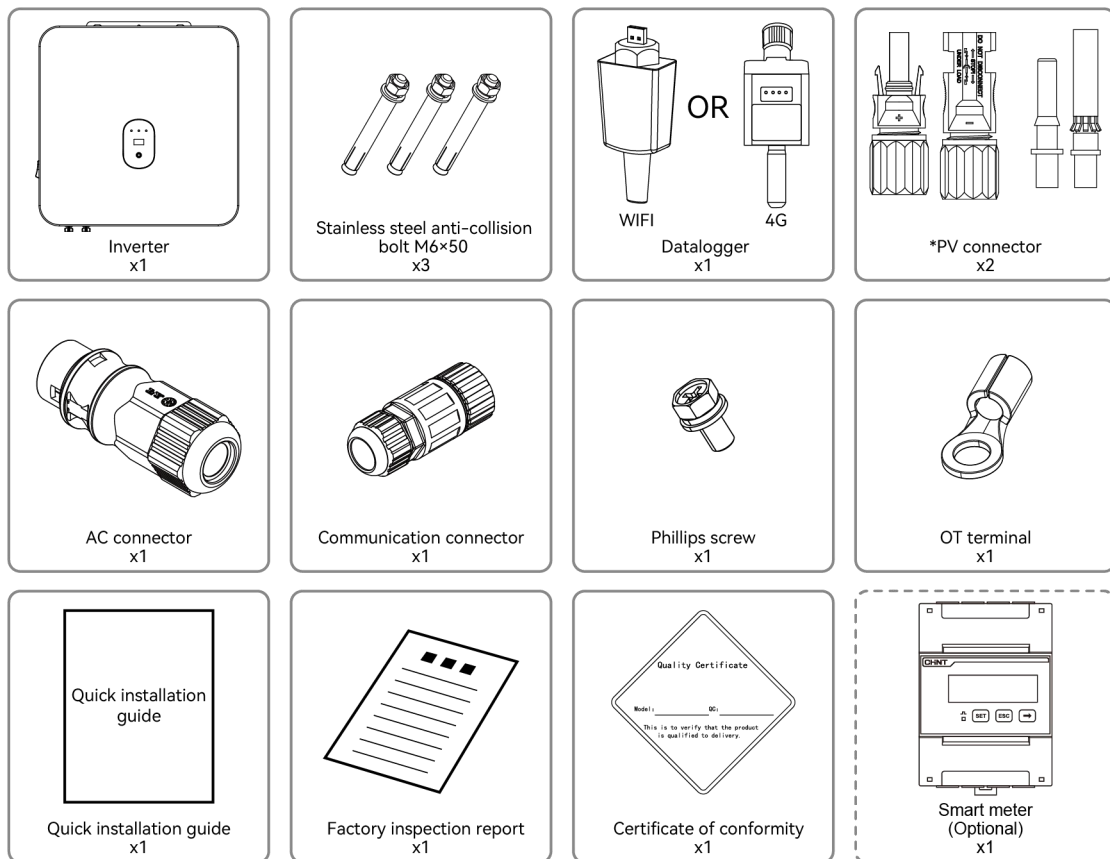

Note(*PV connector):The number of PV connectors varies among different models, and the exact quantity should be confirmed by referring to the actual product.

3.2 Tool Preparation



3.3 Installation Environment Requirements

To ensure reliable and safe operation, select a suitable installation site:

- Mount the inverter vertically on a strong, flat wall.
- Avoid direct sunlight, rain, and high humidity.
- Ensure good ventilation and clearance around the inverter:
 - Top&Bottom&Sides: ≥ 500 mm
 - Front: ≥ 1000 mm
- Ambient temperature range: -25 °C to $+60$ °C
- Avoid installation in areas with corrosive gas, conductive dust, or strong vibration.
- Ensure that surrounding objects and surfaces follow the clearance distances indicated in the diagram to allow proper heat dissipation and sufficient space for removing the cables.

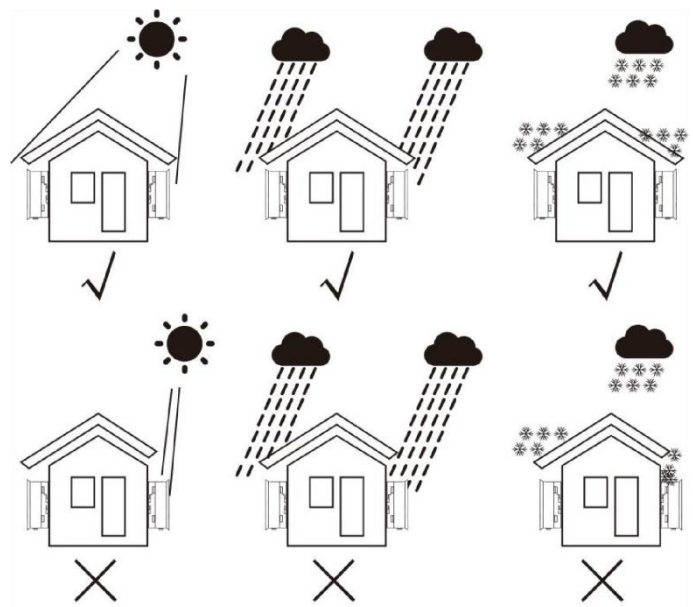
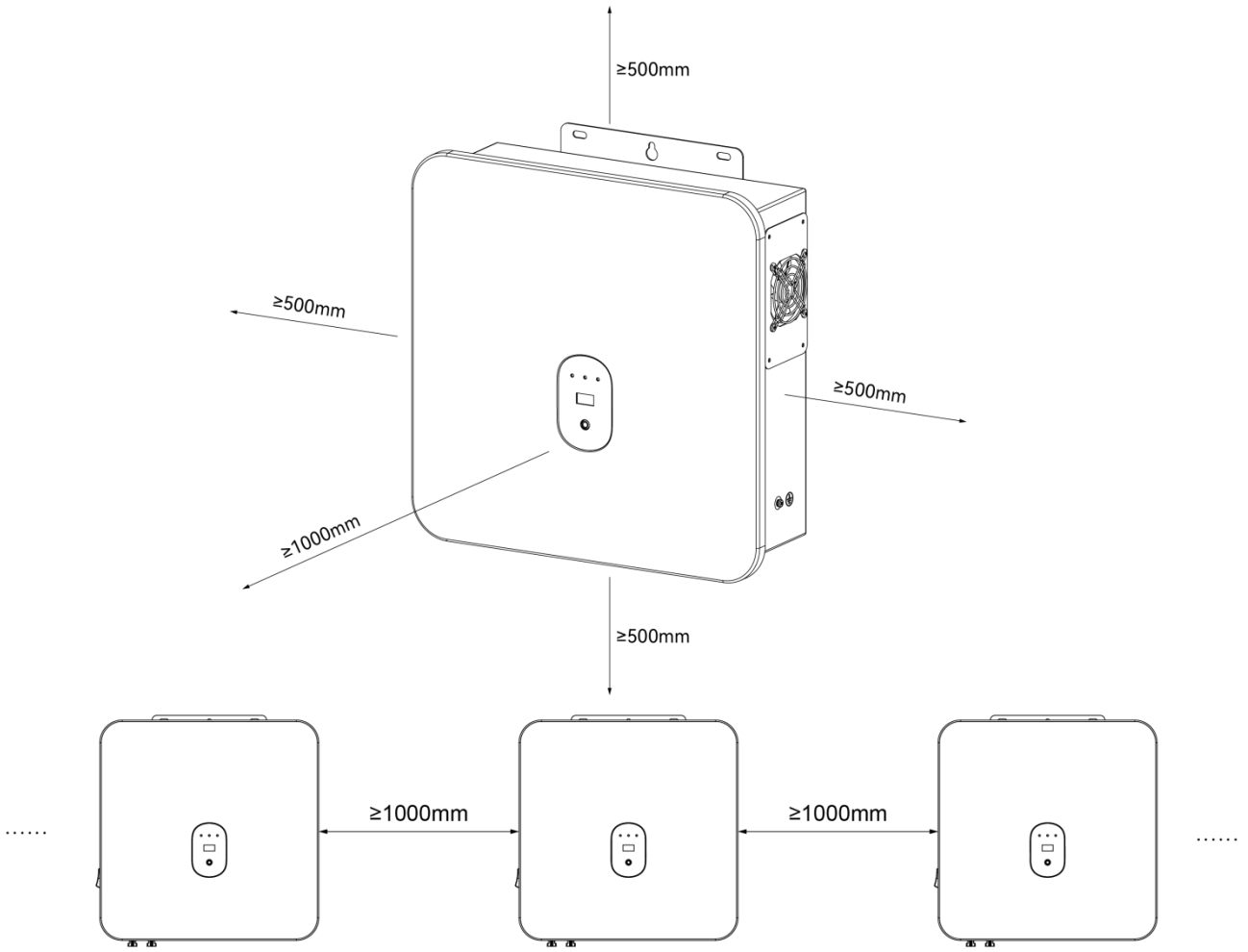

3.4 Mounting Procedure

1. Use the three positioning points at the top of the quick installation manual to mark the drilling points.
2. Drill holes and insert expansion bolts.
3. Loosen the screws and remove both the screws and the washers.
4. Lift the inverter, position it at the marked points, and secure it by tightening the screws and washers.
5. Check that the inverter is level and stable.

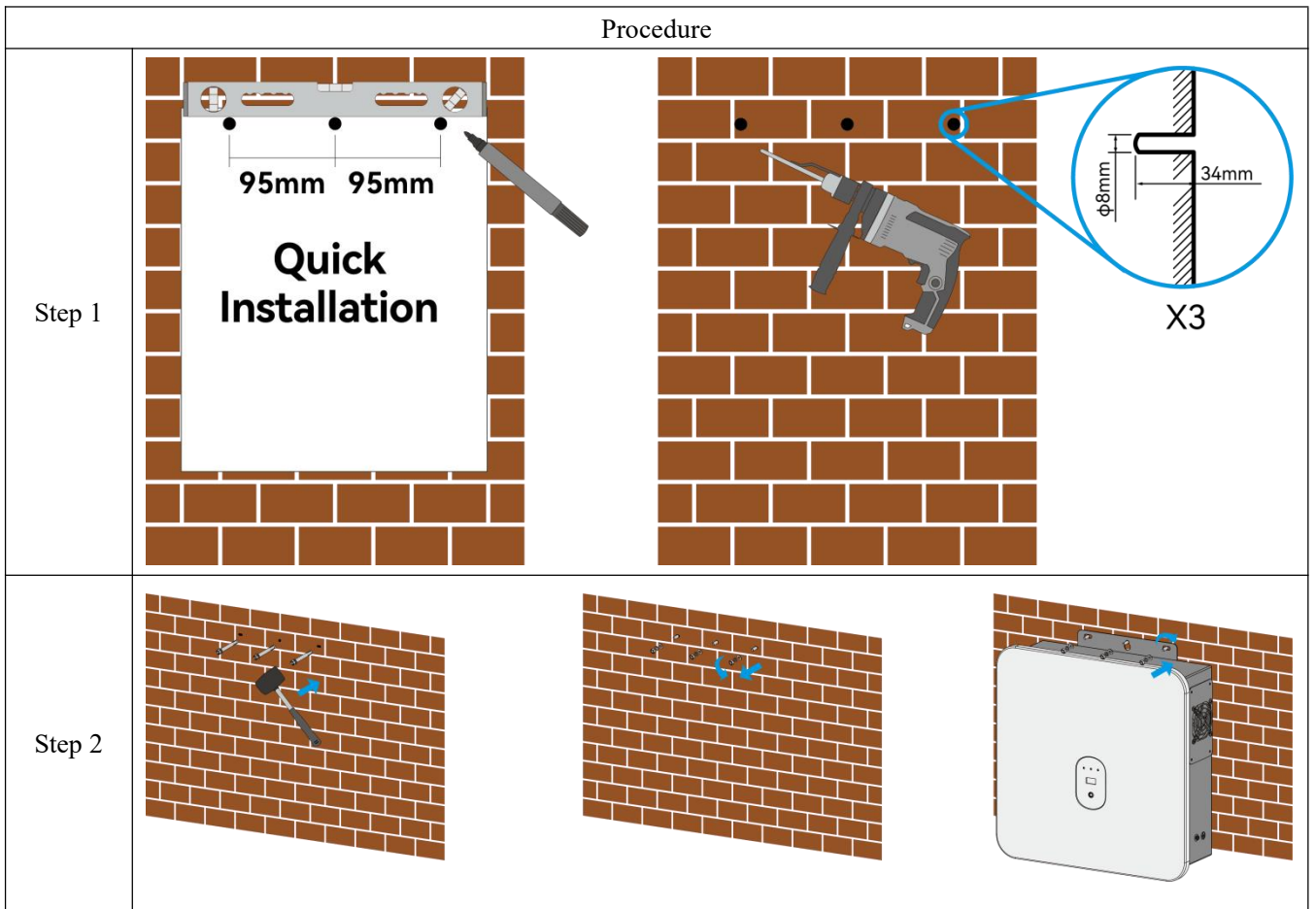

Warning: Two persons are recommended when lifting the inverter to avoid injury or damage.



Note: Loosely tighten the three screws first to hang the inverter. Then slightly adjust the inverter to the good position before diagonally tightening the screws completely.

3.5 Electrical Connections

Before starting the electrical installation, please be aware of the following precautions.

- The cables used for electrical connections must be dedicated photovoltaic (PV) cables. All electrical connections must comply with local electrical regulations.
- All wiring and cabling processes must be performed by qualified personnel.
- Always keep the breakers of the source side (PV, AC) in status of switched off during the installation process.
- Always keep the DC switch on the left side of the inverter in status of switched off during the installation process. See section 2.1 to find the position of DC switch.
- Verify and double confirm that the PV inputs are connected to the inverter with the correct polarity.
- Verify and double confirm that all the voltages at the connecting point (PV input, grid connection) are in the valid range of the inverter. See specification to find the voltage range.
- Verify and double confirm that all the wires and cables are in good electrical condition before installation.



Warning: Always use a protective breaker if applicable and keep the breaker in disconnected status during electrical connection.



Warning: Always measure terminal voltage and confirm the reading is 0 before electrical connection. DO NOT make electrical connection with live voltage!



Warning: Be cautious to prevent accidentally shorting any AC terminals (L-N or L-L) or DC terminals (positive-negative) during electrical connection.

3.5.1 PV Connection

The inverter has a few sets of MPPT connections for PV input. Please be aware of the following operations during PV connection.

- Different models are equipped with different numbers of PV terminals.
- Always keep the DC switch of the inverter in the status of OFF during the PV connection process. See section 2.1 to find the position of DC switch.
- Do not connect the PV string to or disconnect the PV string from the inverter immediately after the inverter stops working. Always wait 5 minutes for inverter to discharge residual energies before any operations.
- Confirm that the PV string voltage does not exceed the inverter's maximum DC input voltage. See specification to find the PV input voltage range of the inverter for your model.
- Confirm whether your model has PV connectors before starting the connection. See the bottom of your inverter to determine and refer to the pictures below for connecting with PV connectors. You need specialized parts and a wrench to make PV connectors for both positive and negative PV cables if the model has PV connectors. If not, simply connect the wire to the corresponding position shown in the picture below.
- Each PV string should have an independent DC fuse and breaker.
- Ensure the total PV power does not exceed the inverter's PV input limit. See specification to find the PV input power limit for the inverter.
- Use colored cables and confirm the correct connection of polarity (positive to positive, negative to negative).

Model	Recommend Cable
All Series	3.3mm ² OR 12 AWG

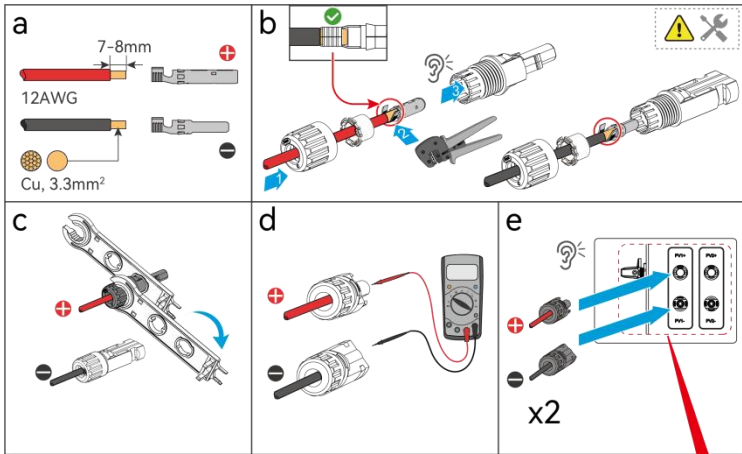

Danger: DO NOT disconnect the PV string from the inverter when there is DC current to avoid generating DC arc.



Danger: Always confirm the DC switch of the inverter is in the status of OFF before connecting or disconnecting the PV string from the inverter.



Danger: Be cautious to prevent accidentally shorting positive and negative terminal of PV string during PV connection.



Danger: DO NOT connect the PV string to or disconnect the PV string from the inverter immediately after the inverter stops working. Always wait 5 minutes for inverter to discharge residual energy before any operations.



Warning: Always keep the protective breaker (if applicable) in disconnected position during PV connection!

3.5.2 AC Connection

Please be aware of the following operations during the AC connection.

- Confirm AC voltage range are compatible with the inverter before connection. See specification to find AC voltage range for your model.
- Confirm the phase and neutral lines are connected correctly.
- Use correctly rated cables, connecting terminals and protective breakers.
- Use colored cables and confirm L cable and N cable are connecting to the right terminal.
- Be cautious to prevent accidentally shorting the L cable and N cable during AC connection.
- Always measure the L-N voltage and confirm the reading is 0 before AC connection or disconnection.

Model	Cable
Gi010K-A1.22-P3NV-L Gi012K-A1.22-P3NV-L Gi015K-A1.22-P3NV-L Gi017K-A1.22-P3NV-L	3.3mm ² OR 12AWG
Gi007K-A1.11-P3NV-L Gi008K-A1.22-P3NV-L Gi009K-A1.22-P3NV-L	2.1mm ² OR 14AWG
Gi004K-A1.11-P3NV-L Gi005K-A1.11-P3NV-L Gi006K-A1.11-P3NV-L	1.3mm ² OR 16AWG
Gi003K-A1.11-P3NV-L	0.9mm ² OR 18AWG

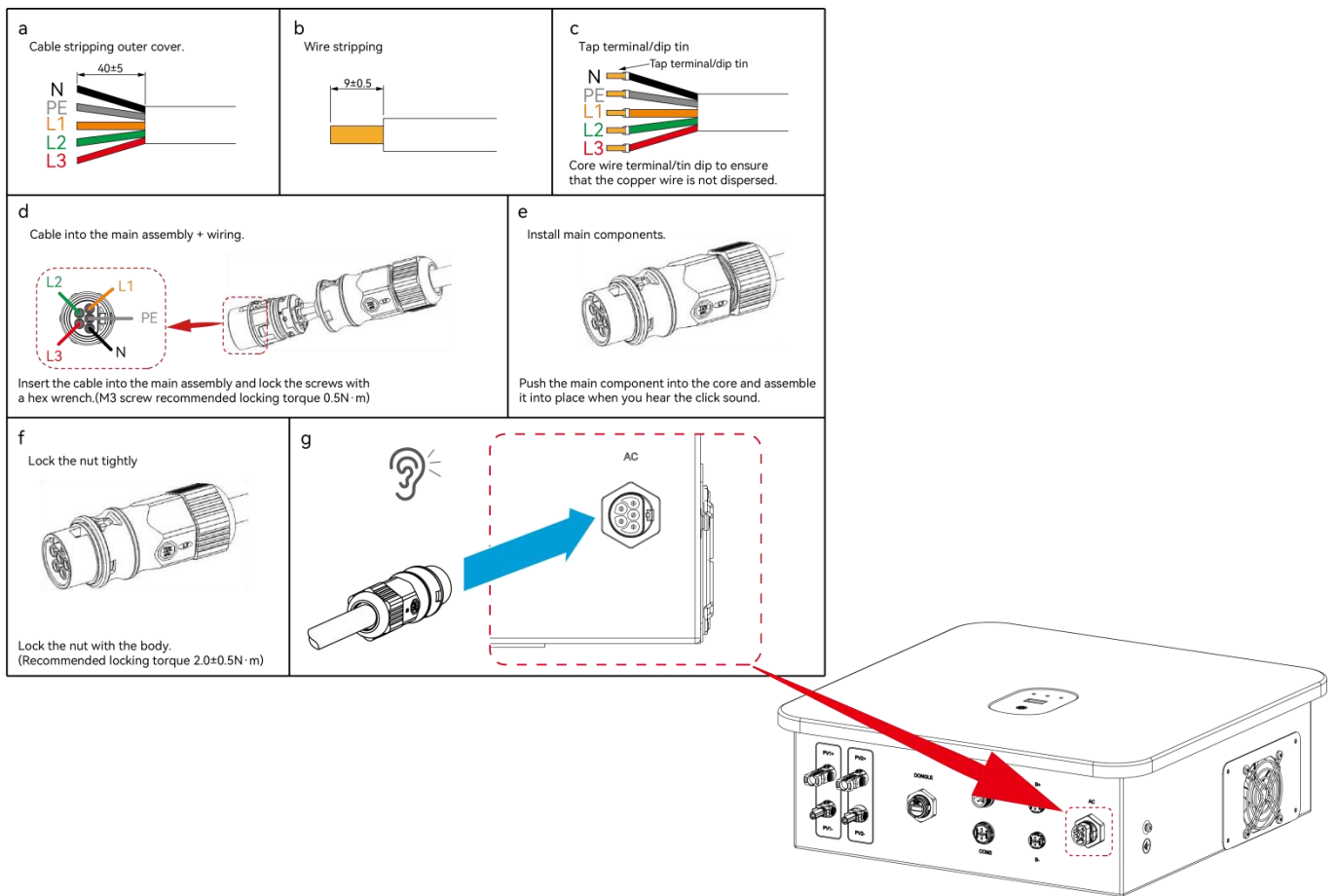



Warning: The residual current monitoring unit (RCMU-Type B) is integrated into the inverter to avoid that the residual current exceeds the limit. The inverter will disconnect with the utility grid quickly once it found the residual current exceeds the limit.

Warning: The type A residual current device(RCD) can be connected to the inverter for protection according to the local laws and regulations. If an external residual current device is connected, an operating current of **300mA** is recommended, otherwise inverter may not work properly.

3.5.3 Grounding

Please be aware of the following operations during earth connection.

- Always connect the PE (Protective Earth) terminal to a reliable earth ground.
- Ground the PV frame and AC distribution circuit according to local standards.
- Ensure all grounding points are tight and corrosion-free.

Type	Model	Recommend Cable
Ground connection	Gi001K-B1.11-P1NV-L; Gi002K-B1.11-P1NV-L; Gi003K-B1.11-P1NV-L;	4mm ² OR 12AWG
	Gi004K-B1.11-P1NV-L; Gi005K-B1.11-P1NV-L; Gi006K-B1.11-P1NV-L; Gi004K-A1.22-P1NV-L; Gi005K-A1.22-P1NV-L; Gi006K-A1.22-P1NV-L;	6mm ² OR 10AWG
	Gi007K-A1.22-P1NV-L; Gi7.5K-A1.22-P1NV-L; Gi008K-A1.22-P1NV-L; Gi007K-A1.33-P1NV-L; Gi7.5K-A1.33-P1NV-L; Gi008K-A1.33-P1NV-L; Gi009K-A1.33-P1NV-L; Gi010K-A1.33-P1NV-L;	10mm ² OR 8AWG

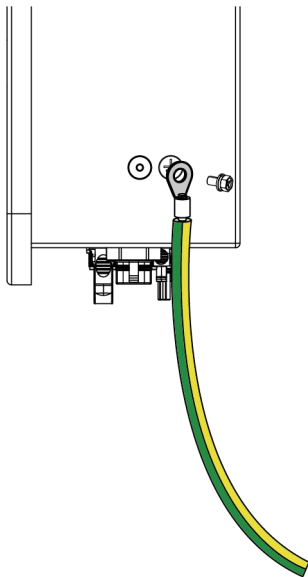

3.5.4 Communication Connection



LT Commitment

1. We only collect and use device data to enhance product quality and service.
2. All data is securely stored and will not be shared with any third party.
3. Users may request to disable this function without affecting normal inverter operation.

3.5.4.1 Data logger

Install the data logger as shown in the diagram. Tighten connectors and ensure waterproof seals are in place.

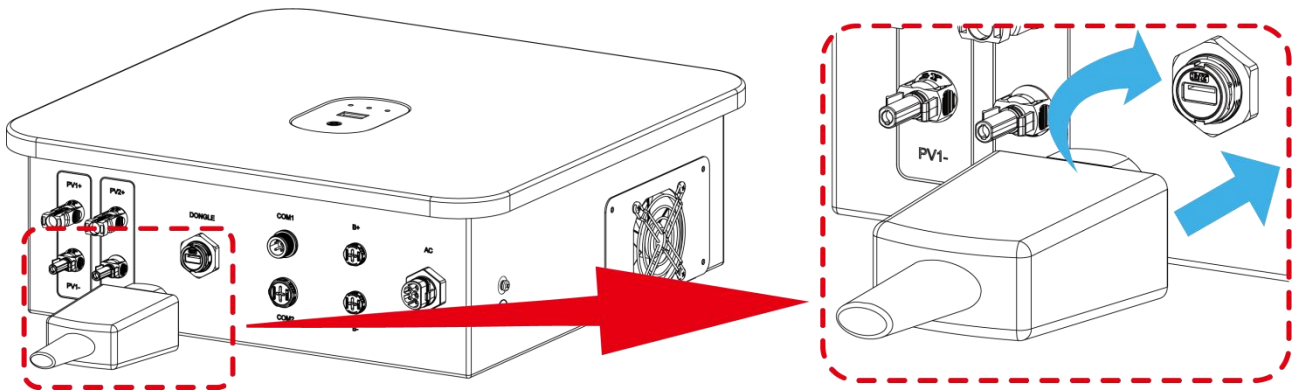

3.5.4.2 Smart Meter Connection(Optional)

To enable export limitation and energy monitoring functions, the inverter supports connection of **Smart Meter**.

Connection Method:

- Smart metre must be installed on the **grid side** of the AC input.
- Ensure the direction of measurement follows the current flow from the inverter to the grid.
- Connect the communication wires between the inverter and smart metre according to terminal labels.
- Keep communication cables as short as possible (recommended < 10 m).

Typical Functions:

- Real-time monitoring of grid import and export power.
- Power limitation (Zero-Export mode).

6. When the self-check is finished, proceed with the configuration steps described below.

Power OFF:

1. If you need to power off the inverter, first switch off the AC breaker.
2. Switch off the DC breaker.
3. Turn off the DC switch.
4. There is residual voltage existing in the inverter after powering off, which needs 5 min to discharge.
Wait at least 5 minutes before you make any operations.

4.2 Display Panel

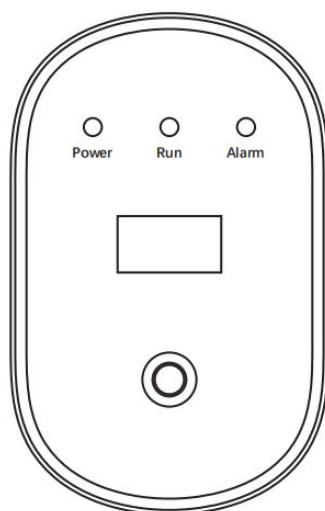

4.3 LED Indicator

Indicator	Color	Status	Meaning
Power	Green	Steady On	PV has power
		Flashing	Self-check
		Off	PV has no power
Run	Green	Steady On	Grid has power, normal running
		Off	Not running
Alarm	Red	Steady On	In fault
		Off	Normal running

4.4 Button

There is only one button in the panel of the inverter to operate the LCD screen. Different press times define the different functions.

- Long stress for 2~3s refers to 'Confirm'.
- Short stress refers to 'Next Page'.

For specific functional operations, please refer to the operation flow below.

4.5 LCD Interface

4.5.1 Display Information

The initial interface displays the inverter status and the current AC output power.

By short-pressing the button, you can view additional information such as total energy generation, DC voltage and current, AC voltage and current, and more.

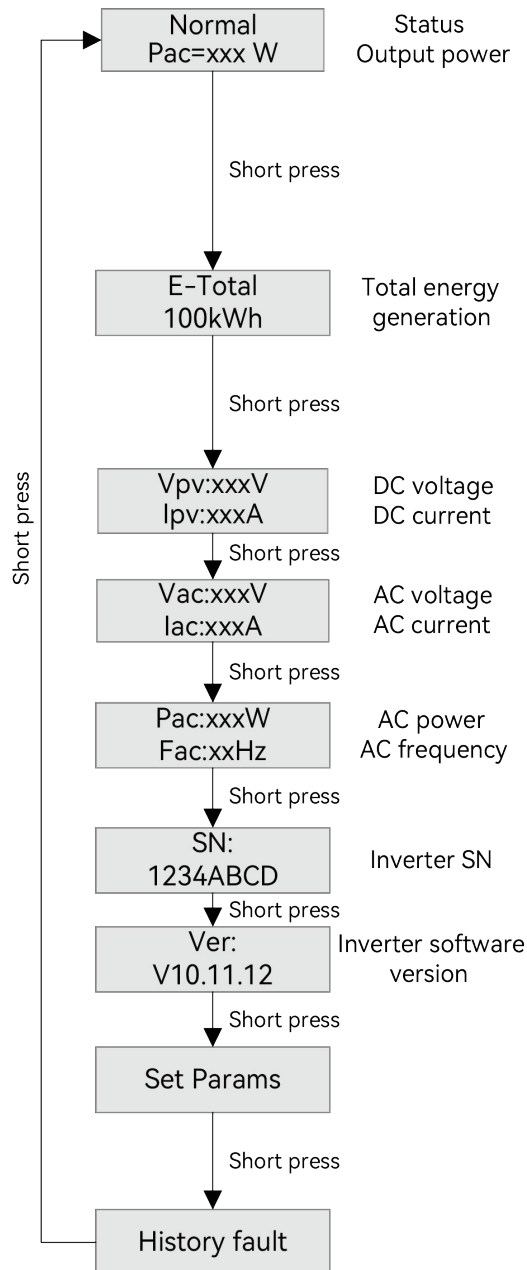

4.5.2 History Fault Settings

You can enter the history fault settings by long-pressing the button when the screen displays the history fault menu. From this menu, you can complete the corresponding configuration related to the history faults.

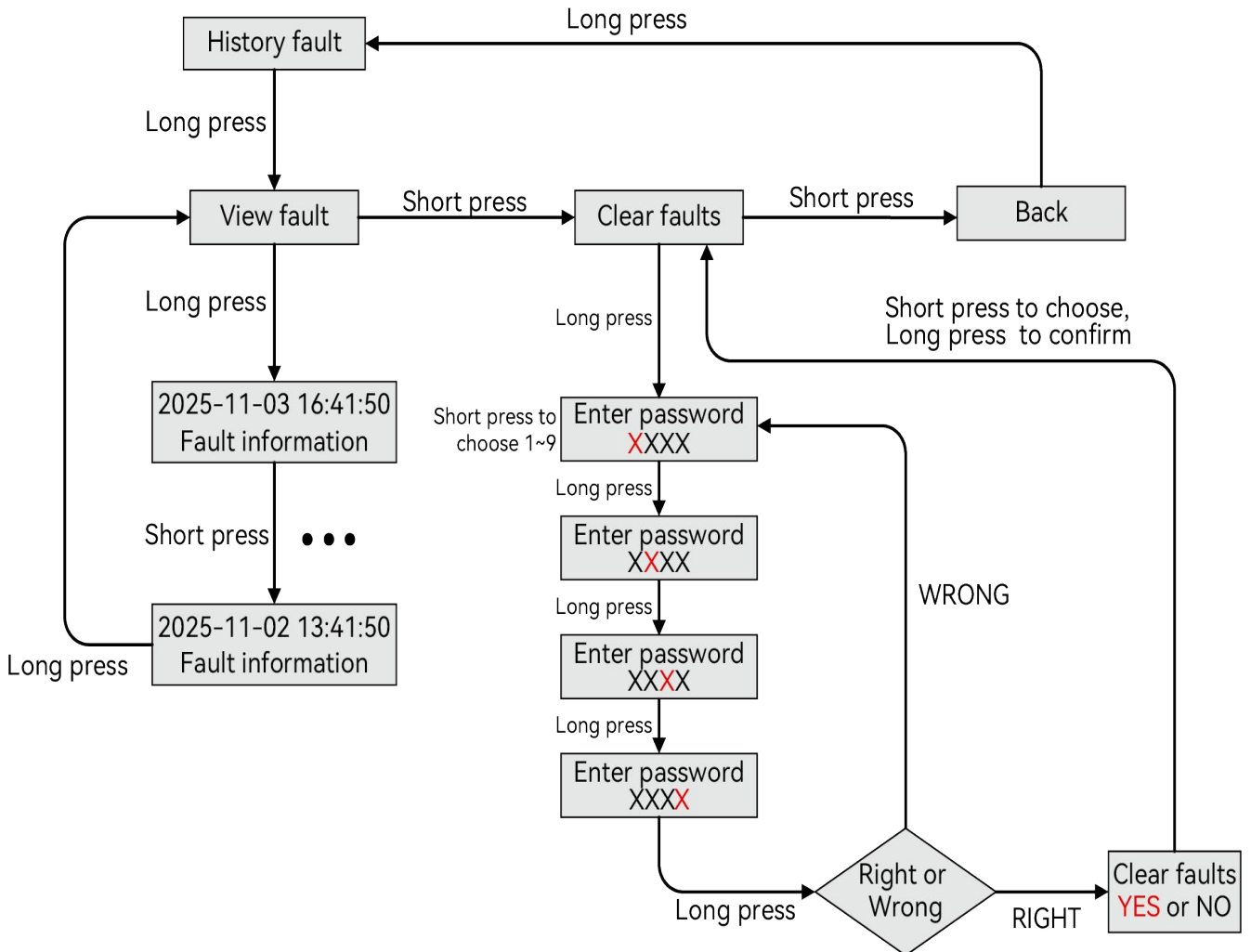

4.5.3 Language Settings

By long-pressing the button in the set params menu, you can enter the language settings. From here, you can select the language you want to display.

4.5.5 Modbus Address Settings

In most cases, this setting does not need to be adjusted.

However, if you need to connect the inverter to an external platform or **parallel inverters**, you can configure the Modbus address here. The address consists of three digits, and the specific value should be set according to the requirements of the external platform.

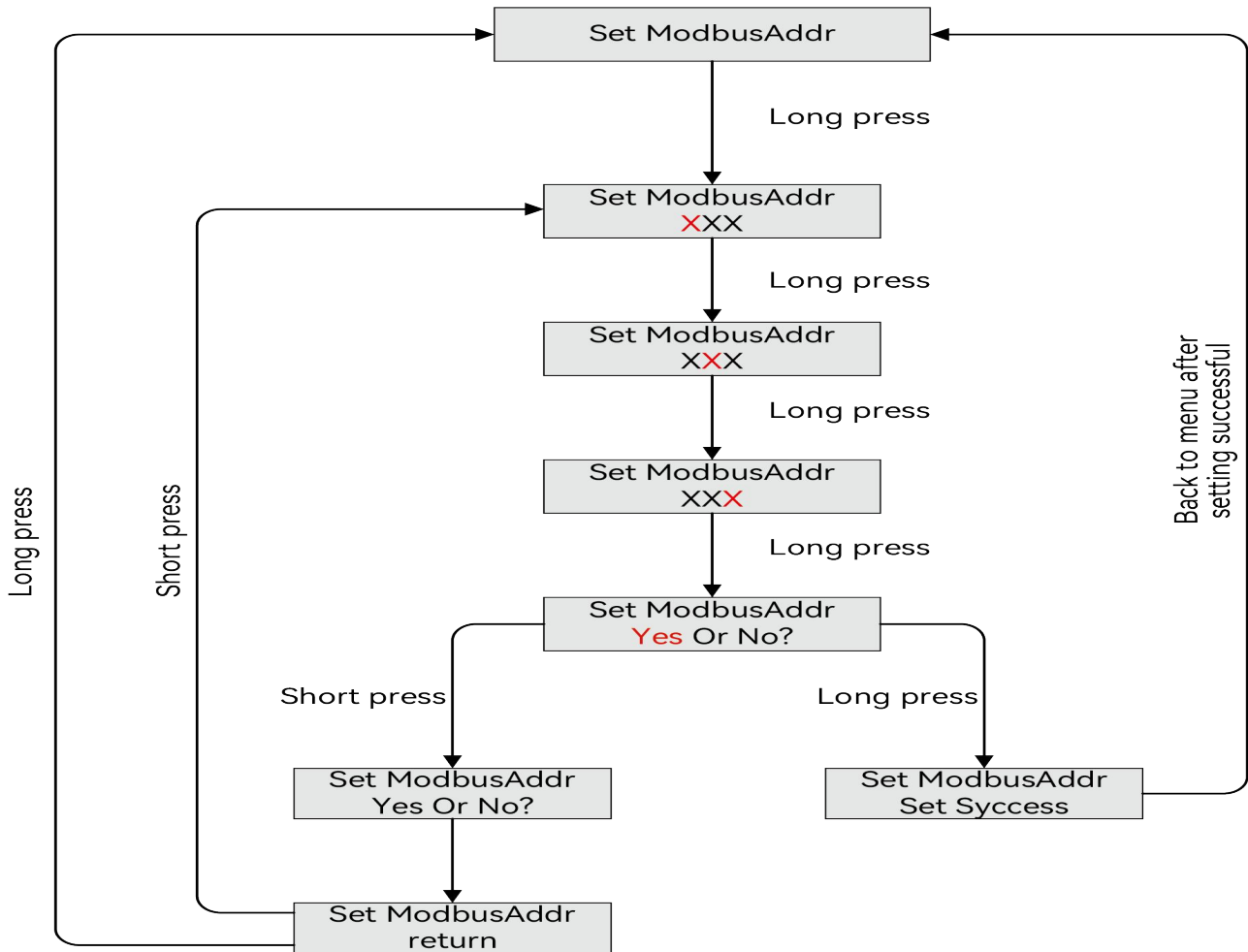

5. Maintenance



Warning: Improper maintenance may cause electric shock or equipment damage. Only qualified personnel should perform internal inspections or repairs.



Caution: Be careful to touch the inverter while it is operating. Some parts may be hot and may cause burns.



Caution: Turn OFF the inverter and wait it to cool down before cleaning or performing any inspections.



Caution: Never use any liquids, solvents, or corrosive materials for cleaning.



Caution: Only professional or qualified electricians are allowed to open the inverter covers.

5.1 Routine Care

The inverter does not require frequent maintenance.

However, keeping the inverter clean helps it work efficiently and last longer.

Tips for maintenance:

- Use a **soft, dry brush or cloth** to remove dust from the surface and heat sink.

- Do **not** use water, spray cleaners, or strong solvents.
- Clean the dust from the fan to ensure proper heat dissipation of the machine.

5.2 Safety Notes for Maintenance

Caution:

Do not touch the inverter while it is operating. Some parts may be hot and can cause burns. Turn **OFF** the inverter and allow it to cool down before cleaning or performing any checks.

Note:

Never use any liquids, solvents, or corrosive materials for cleaning. Only qualified electricians should open the inverter cover.

6. Troubleshooting

Fault Code	Description	Proposed Suggestion
1	Utility Loss	<ol style="list-style-type: none"> 1. Check whether the utility is abnormal. 2. Check whether the AC cable is connected correctly. 3. Restart the inverter to check if the fault still exists.
2	Grid phase overvoltage	
3	Grid line overvoltage	
4	Peak overvoltage	
5	Grid phase undervoltage	
6	Grid line undervoltage	
7	10-minute overvoltage	
8	LVRT undervoltage	
9	HVRT overvoltage	
10	Grid Voltage imbalance	
11	Grid waveform overvoltage	
12	Grid waveform undervoltage	
13	Grid Rapid outage protection	
14	Grid overfrequency	
15	Grid underfrequency	
16	Grid Frequency Instability	
17	Grid Phase Instability	
18	Anti-islanding	
19	Grid phase loss	
20	Grid Phase Sequence abnormal	
21	Neutral Line Loss (Split phase)	
1001	PV Input overvoltage	Restart the inverter to check if the fault still exists.
1004	PV Input overcurrent	Restart the inverter to check if the fault still exists.
1002	PV continuous Hardware overcurrent	Check whether the PV wiring is correct and not loose.
1005	PV String connect reversed	Check if the PV wiring is reversed
1006	PV String unconnected	Check whether the PV wiring is correct and not loose.
4002	External Fan abnormal	Check fan connection, clean dust, or replace fan if necessary.
6012	Relay Device Failure	Internal relay test failed. Power off inverter, wait for cooling, and restart. If repeated, contact after-sales service
7001	Abnormal GFCI 30mA	Measure insulation resistance and inspect for grounding faults on PV side or AC output.
7002	Abnormal GFCI 60mA	
7003	Abnormal GFCI 150mA	
7004	Abnormal GFCI	
7013	GFCI multiple failures	Inspect for persistent insulation degradation or water ingress. Contact support if not resolved.

The above are the fault codes and the corresponding descriptions, along with their solutions. Furthermore, warnings are usually triggered by external conditions and do not interfere with the normal operation of the machine. If the machine frequently reports faults and affects its normal operation, it is recommended that you contact the after-sales service.

7. Specification

Parametre/Model	Gi003K-A1.11-P3NV-L	Gi004K-A1.11-P3NV-L	Gi005K-A1.11-P3NV-L	Gi006K-A1.11-P3NV-L	Gi007K-A1.11-P3NV-L
PV input Data					
Recommend max. PV capacity (W)	4500	6000	7500	9000	10500
Max. PV input voltage (V)	1100				
Rated voltage (V)	600				
Start voltage (V)	160				
MPPT voltage range (V)	120~1000				
Max. PV input current (A)	20				
Max. short-circuit current per MPPT (A)	30				
Max. Inverter backfeed current to the array (A)	0				
MPPT number	1				
NO. of PV strings per MPPT	1				
AC output Data					
Rated output power (W)	3000	4000	5000	6000	7000
Max output power (VA)	3300	4400	5500	6600	7700
Max output current (A)	5.0	6.7	8.3	10	11.7
Inrush current (A)	4				
Max. output fault current (A)	420A/5.7us				
Max. Output overcurrent protection(A)	5.8	7.8	9.7	11.7	13.6
Operation phase	3L+N+PE				
Rated output voltage (V)	220/380;230/400				
Rated frequency (Hz)	50/60				
THDi	<3%				
Power factor	1(0.8leading~0.8lagging)				
Efficiency					
Max. efficiency	98.50%				
EU efficiency	98.20%				
Protection					
DC switch	Yes				
DC reverse-polarity connection protection	Yes				
Thermal protection	Yes				
AC overvoltage/current protection	Yes				
AC short circuit protection	Yes				
Ground fault circuit interrupter	Yes				
Power network monitoring	Yes				
Island protection	Yes				
Ground fault monitoring	Yes				
Insulation resistance monitoring	Yes				
Residual current detection	Type B				
Arc fault circuit interrupter	Optional				
Surge protection	AC Typell/DC Typell				
General					
Dimensions (W*H*D mm)	459*459*153.5				
Weight (kg)	14				
Noise (dB)	<45				
Operating temperature (°C)	-25~60(>45°C derating)				
Type of cooling	Smart air cooling				
Topology	Transformless				

Communication	RS485/CAN
Permissible altitude (m)	3000(>2000m derating)
Permissible ambient humidity	0~100%
Pollution degree	III
Over voltage category	III(AC), II(DC)
Protective class	I
Ingress protection (IP) grade	IP66
Warranty	5/10 years;(More info refers to the warranty policy)
Display	LCD+LED

Parametre/Model	Gi008K-A1.2 2-P3NV-L	Gi009K-A1.2 2-P3NV-L	Gi010K-A1.2 2-P3NV-L	Gi012K-A1.2 2-P3NV-L	Gi015K-A1.2 2-P3NV-L	Gi017K-A1.2 2-P3NV-L
PV input Data						
Recommend max. PV capacity (W)	12000	13500	15000	18000	22500	22500
Max. PV input voltage (V)	1100					
Rated voltage (V)	600					
Start voltage (V)	160					
MPPT voltage range (V)	120~1000					
Max. PV input current (A)	20/20					
Max. short-circuit current per MPPT (A)	30/30					
Max. Inverter backfeed current to the array (A)	0					
MPPT number	2					
NO. of PV strings per MPPT	1					
AC output Data						
Rated output power (W)	8000	9000	10000	12000	15000	17000
Max output power (VA)	8800	9900	11000	13200	16500	18700
Max output current (A)	13.3	15.0	16.7	20.0	25.0	28.3
Inrush current (A)	4					
Max. output fault current (A)	420A/5.7us					
Max. Output overcurrent protection(A)	15.6	17.5	19.5	23.4	29.2	33.1
Operation phase	3L+N+PE					
Rated output voltage (V)	220/380;230/400					
Rated frequency (Hz)	50/60					
THDi	<3%					
Power factor	1(0.8leading~0.8lagging)					
Efficiency						
Max. efficiency	98.50%					
EU efficiency	98.20%					
Protection						
DC switch	Yes					
DC reverse-polarity connection protection	Yes					
Thermal protection	Yes					
AC overvoltage/current protection	Yes					
AC short circuit protection	Yes					
Ground fault circuit interrupter	Yes					

Power network monitoring	Yes
Island protection	Yes
Ground fault monitoring	Yes
Insulation resistance monitoring	Yes
Residual current detection	Type B
Arc fault circuit interrupter	Optional
Surge protection	AC Typell/DC Typell
General	
Dimensions (W*H*D mm)	459*459*153.5
Weight (kg)	14
Noise (dB)	<45
Operating temperature (°C)	-25~60(>45°C derating)
Type of cooling	Smart air cooling
Topology	Transformless
Communication	RS485/CAN
Permissible altitude (m)	3000(>2000m derating)
Permissible ambient humidity	0~100%
Pollution degree	III
Over voltage category	III(AC), II(DC)
Protective class	I
Ingress protection (IP) grade	IP66
Warranty	5/10 years;(More info refers to the warranty policy)
Display	LCD+LED